

# Dymax ECE Series UV Light-Curing Flood-Lamp Systems User Guide

---

## Flood-Lamp Curing Systems

- Instructions for Safe Use
- Setup and Operation
- Maintenance
- Ordering Spare Parts and Accessories



### **About Dymax**

#### **UV/Visible light-curable adhesives. Systems for light curing, fluid dispensing, and fluid packaging.**

Dymax manufactures industrial adhesives, light-curable adhesives, epoxy resins, cyanoacrylates, and activator-cured adhesives. We also manufacture a complete line of manual fluid dispensing systems, automatic fluid dispensing systems, and light-curing systems. Light-curing systems include LED light sources, spot, flood, and conveyor systems designed for compatibility and high performance with Dymax adhesives.

Dymax adhesives and light-curing systems optimize the speed of automated assembly, allow for 100% in-line inspection, and increase throughput. System designs enable stand-alone configuration or integration into your existing assembly line.

Please note that most dispensing and curing system applications are unique. Dymax does not warrant the fitness of the product for the intended application. Any warranty applicable to the product, its application and use is strictly limited to that contained in the Dymax standard Conditions of Sale. Dymax recommends that any intended application be evaluated and tested by the user to insure that desired performance criteria are satisfied. Dymax is willing to assist users in their performance testing and evaluation by offering equipment trial rental and leasing programs to assist in such testing and evaluations.

# Contents

<b>Introduction.....</b>	<b>4</b>
Introduction to the User Guide .....	4
Where to Get Help .....	4
<b>Safety.....</b>	<b>4</b>
General Safety Considerations .....	4
Safety Symbol Index .....	5
Specific Safety Considerations.....	5
Dymax UV Light-Curing System Safety Considerations .....	5
<b>Product Overview .....</b>	<b>7</b>
Description of the ECE Series Flood Systems.....	7
System Components.....	8
<b>Assembly and Setup.....</b>	<b>9</b>
Unpacking and Inspecting Your Shipment.....	9
Parts Included in an ECE UV Light-Curing Flood-Lamp System .....	10
<b>System Interconnection .....</b>	<b>11</b>
<b>Operation .....</b>	<b>14</b>
Starting the ECE Flood Lamp .....	14
Loading Materials in the Light Shield .....	15
Operating the Shutter .....	16
Operational Safety Interlock for ECE Flood System.....	16
<b>Cleaning and Maintenance .....</b>	<b>16</b>
ECE Flood Lamp Maintenance .....	16
ECE Light Shield Maintenance .....	20
ECE ZIP Shutter Maintenance .....	20
<b>Troubleshooting.....</b>	<b>25</b>
<b>Spare Parts and Accessories .....</b>	<b>27</b>
Replacement/Spare Parts.....	27
Optional Accessories .....	27
<b>Specifications.....</b>	<b>28</b>
Specifications.....	28
<b>Definition of Terms .....</b>	<b>30</b>
<b>Warranty .....</b>	<b>31</b>
<b>Index.....</b>	<b>31</b>

# Introduction

## Introduction to the User Guide

This guide describes how to assemble, use, and maintain a Dymax ECE series flood-lamp system safely and efficiently.

## Intended Audience

Dymax prepared this user guide for experienced process engineers, technicians, and manufacturing personnel. If you are new to UV light sources and do not understand the instructions, contact Dymax Application Engineering to answer your questions before using the equipment.

## Where to Get Help

Dymax Customer Support and Application Engineering teams are available in the United States, Monday through Friday, from 8:00 a.m. to 5:30 p.m. Eastern Standard Time. You can also email Dymax at [info@dymax.com](mailto:info@dymax.com). Contact information for additional Dymax locations can be found on the back cover of this user guide.

Additional resources are available to ensure a trouble-free experience with our products:

- Detailed product information on [www.dymax.com](http://www.dymax.com)
- Dymax adhesive Product Data Sheets (PDS) on our website
- Material Safety Data Sheets (MSDS) provided with shipments of Dymax adhesives

# Safety



**WARNING!** *If you use an ECE UV flood-lamp system without first reading and understanding the information in this user guide, injury can result from exposure to UV light. To reduce the risk of injury, read and ensure you understand the information in this user guide before assembling and operating an Dymax ECE UV flood- lamp system.*

*To use an ECE flood-lamp system safely, it must be set up and operated in accordance with the instructions given by Dymax. Using the system in any other manner will impair the protection of the system. Dymax assumes no liability for any changes that may impair the protections of the ECE flood-lamp curing system.*

## General Safety Considerations

All users of an ECE light-curing flood-lamp system should read and understand this user guide before assembling and using the system.

To learn about the safe handling and use of light-curable formulations, obtain and read the MSDS for each product. Dymax includes an MSDS with each adhesive sold. In addition, fluid product MSDS can be requested through the Dymax website.

## Safety Symbol Index

The following symbols are displayed on the Dymax ECE flood-lamp systems. Please see below for their meanings.



Refer to Equipment Manual



Gloves Required



Eye Protection Required



Warning!



Caution! Hot Surface



Warning! UV Light Hazard



Warning! Electrical Shock Hazard

## Specific Safety Considerations

Dymax ECE series flood-lamp systems are designed to maximize operator safety and minimize exposure to UV light-curing energy. To use the systems safely, they must be set up and operated in accordance with the instructions in this user guide. Dymax assumes no liability for any changes that may impair the protections of the ECE flood-lamp curing system. Please also read and understand the safety considerations unique to UV light-curing systems as described below.



**WARNING!** Looking directly at the UV light emitted by an ECE flood lamp can result in eye injury. To prevent eye injury, never look directly at the high-intensity light and always wear protective goggles (provided).

## Dymax UV Light-Curing System Safety Considerations

Operators must understand these four concepts to use the UV light source safely:

- UV exposure
- High-temperature surfaces
- Ozone
- Bright, visible light

Each is described below.

## UV Exposure

Standard Dymax UV light-curing systems and bulbs have been designed primarily to emit UVA light (Figure 1). UVA light is generally considered the safest of the three UV ranges: UVA, UVB, and UVC. The American Conference of Governmental Industrial Hygienists (ACGIH) does recommend Threshold Limit Values (TLVs) for ultraviolet light.

The strictest interpretation of the TLV (over the UVA range) for workers' eyes and skin allows continuous exposure up to 1 mW/cm<sup>2</sup> (intensity). Unless you are placing bare hands into the curing area, it is unusual to exceed these limits. To put 1 mW/cm<sup>2</sup> limit into perspective, a cloudless summer day will typically exceed 3 mW/cm<sup>2</sup> of UVA light, and also include the more dangerous UVB light (primarily responsible for suntans, sun burns, and skin cancer) as well.

**Figure 1. UV Spectrum**

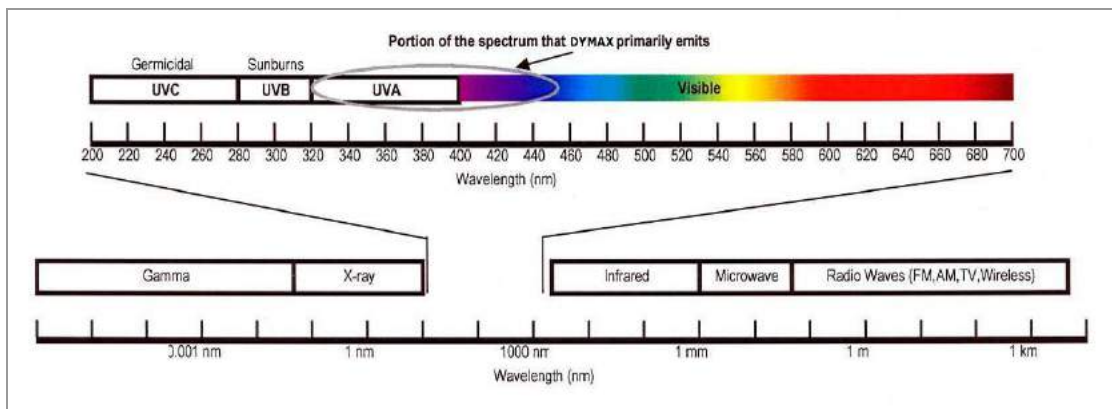

## Checking the Workstation

The human eye cannot detect "pure" UV light, only visible light. A radiometer should be used to measure stray UV light to confirm the safety of a UV light-curing process. A workstation that exposes an operator to more than 1 mW/cm<sup>2</sup> of UVA continuously should be redesigned.

## Protecting Operators

Light-curing technology can be a regulatory compliant, "worker-friendly" manufacturing process when the proper safety equipment and operator training is utilized. There are two ways to protect operators from UV exposure: shield the operator and/or shield the source.

**UV-Blocking Eye Protection** — UV-blocking eye protection is recommended when operating UV light-curing systems. Both clear and tinted UV-blocking eye protection is available from Dymax.

**UV-Blocking Skin Protection** — Where the potential exists for UV exposure upon skin, opaque, UV-blocking clothing, gloves, and full-face shields are recommended.

## Shield the Source of UV

Any substrate that blocks UV light can be used as a shield to protect workers from stray UV light. The following materials can be used to create simple shielding structures:

**Rigid Plastic Film** — Transparent or translucent/UV-blocking plastics (typically polycarbonate or acrylic) are commonly used to create shielding where some level of transparency is also desired.

**Flexible Film** — Translucent UV-blocking, flexible urethane films can be used to quickly create workstation shielding.

## Ozone

Standard Dymax bulbs (UVA type) generate an insignificant amount of UVC and therefore essentially no ozone. Some UV light-curing systems, like those used to cure UV inks, emit primarily “shortwave” (UVB and UVC) energy. Upon exposure to UVC light (specifically <240 nm), oxygen molecules (O<sub>2</sub>) split into oxygen atoms (O) and recombine with O<sub>2</sub> to create ozone O<sub>3</sub>.

## High-Temperature Surfaces

Surfaces exposed to high-intensity curing lights will rise in temperature. The intensity, distance, exposure time, cooling fans, and the type/color of the surface can all affect the actual surface temperature. In some cases, exposed surfaces can reach temperatures capable of producing a burn or causing damage to a substrate. In these cases, care must be taken to ensure either a more moderate surface temperature or appropriate protection/training for operators.

## Bright, Visible Light

The bright, visible light emitted by some UV light-curing systems can be objectionable to some workers and can cause eyestrain. Tinted eye protection and/or opaque/tinted shielding can be utilized to address this concern.

# Product Overview

## Description of the ECE Series Flood Systems

Dymax ECE UV light-curing flood lamps are general-purpose units for the curing of UV light-curable adhesives, coatings, and inks. They have extensive use in a wide variety of applications such as bonding, potting, sealing, and encapsulating. These light sources are extremely unique in that they offer exceptional versatility and expandability.

The design of these units has been carefully considered to allow the light source to be successfully utilized in a wide variety of manufacturing situations. Further versatility is found in the ability to be configured in a wide variety of production situations.

Each unit is designed and shipped in a unitized configuration for easy bench-top mounting with all controls and functions right at the hands of the operator.

**NOTE:** Please allow 12 inches (30.5 cm) of clearance between the ECE curing system and any objects/structures to ensure that airflow to the system is not impeded.

## System Components

**Figure 2. Typical UV Flood-Lamp System**

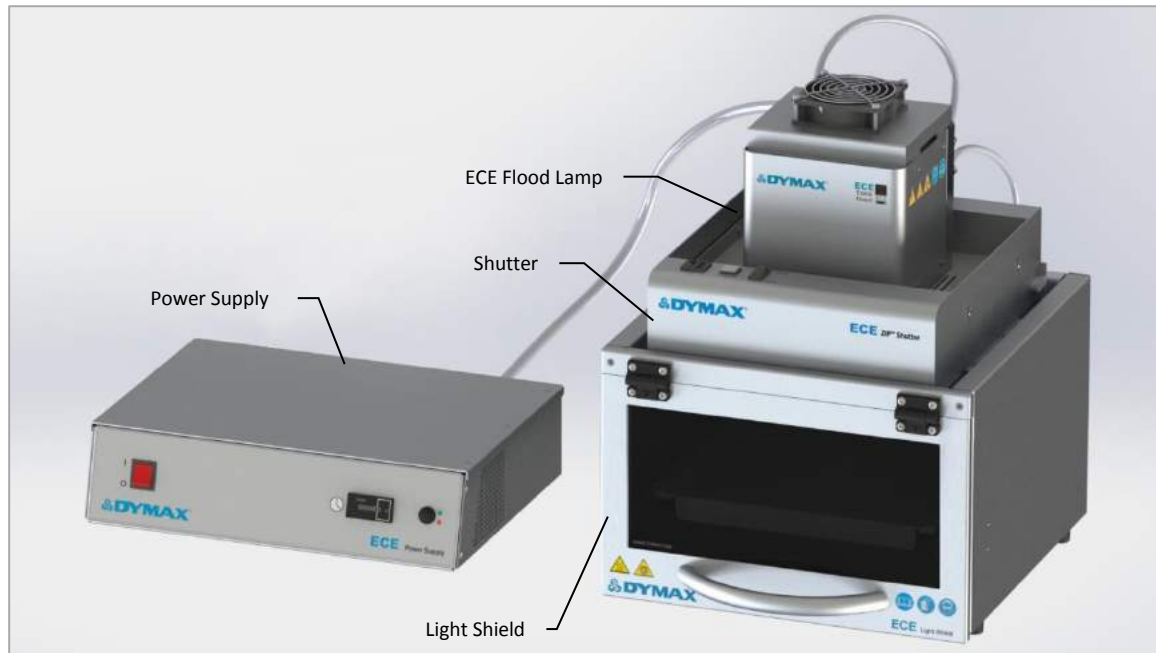

### ECE Flood Lamps

#### ECE Solid-State Power Supply

This power supply allows external electrical inputs and provides power to the ECE Flood Lamps. The power supply contains the on/off power switch and hour meter. The power supply also houses its own cooling fans and power distribution for optional accessories. The rear panel has an integrally fused AC-power receptacle and a 9-pin female connector. The solid-state power supply yields reliable and stabilized lamp voltage in virtually any electrical system in the world. Other than ensuring a properly configured plug is employed, no other adjustment of settings is required. The power supply also conditions the electrical power to the lamp providing longer, more reliable lamp life.

#### ECE 2000

The Dymax ECE 2000 is a general purpose UV light-curing flood lamp with an effective curing area of approximately 8" x 8" ( 20.3 cm x 20.3 cm), making it ideal for batch processing or curing large areas.

Item	Part Number
ECE 2000 Flood Lamp	40835
ECE 2000 Modular Power Supply and Housing – No Power Cord*	40965
ECE 2000 Modular Power Supply and Housing – Asian Version, Type G Power Cord	40995
ECE 2000 Modular Power Supply and Housing – North American Version, Cord with 120V Plug	40985

\* The appropriate power cord will be added for European customers



## ECE 5000

The Dymax ECE 5000 is a general purpose UV light-curing flood lamp with an effective curing area of approximately 5" x 5" (12.7 cm x 12.7 cm). The unit is ideal for small batch processing of UV adhesives and potting compounds.

Comparatively, it provides more than twice the output intensity of an ECE 2000 flood lamp for faster curing capability and the additional ability to cure conformal coating resins.

Item	Part Number
ECE 5000 Flood Lamp	40845
ECE 5000 Modular Power Supply and Housing – No Power Cord*	40915
ECE 5000 Modular Power Supply and Housing – Asian Version, Type G Power Cord	40935
ECE 5000 Modular Power Supply and Housing – North American Version, Cord with 120V Plug	40925

\* The appropriate power cord will be added for European customers

## Electric ECE ZIP™ Shutter

The Dymax ECE *ZIP Shutter* (retractable) allows timed light exposure, reduces heat on work area surfaces, and reduces operator exposure to UV light.

Item	Part Number
ECE ZIP™ Shutter	40885

## ECE Light Shield

The Dymax light shield is a complete enclosure with 360 degrees of shielding. The light shield features an UV-opaque safety glass window that filters out ultraviolet radiant energy and allows visible light to pass through so that objects can be observed during the curing process.

Item	Part Number
ECE Light Shield	40785

# Assembly and Setup

## Unpacking and Inspecting Your Shipment

When your ECE flood-lamp system arrives, inspect the boxes for damage and immediately notify the shipper of any box damage.

Open each box and check for equipment damage. If parts are damaged, notify the shipper and submit a claim for the damaged parts. Contact Dymax so that new parts can be shipped to you immediately.

Check that the parts included in your order match those listed below. If parts are missing, contact your local Dymax representative or Dymax Customer Support to resolve the problem.

## Parts Included in an ECE UV Light-Curing Flood-Lamp System

Refer to Figure 3.

- **ECE 2000 (PN 40835) or 5000 (PN 40845) Lamp/Reflector Assembly Housing (1)** - Contains the reflector, UV lamp, lamp sockets, high-voltage starter, and three circular connectors.
- **Interconnection Cable (2)** – PN 40695 - Connects the power supply to the lamp/reflector assembly housing.
- **Power Cord (3)** – Dependent on model ordered. Available options listed below:
  - Standard North American Power Cord (PN 41601)
  - Type G Power Cord (PN 41606)
  - No Power Cord (Note: For European customers, the appropriate power cord will be added)
- **Solid-State Power Supply (4)**
- **ECE Light Shield (5)** PN 40785
- **ECE ZIP Shutter (6)** PN 40885
- **Goggles (7)** PN 35285
- **Two Interconnect Cables (8)**
  - PN 40879 - Connects the lamp/reflector housing to the ZIP shutter
  - PN 40878 - Connects the lamp/reflector housing to the ECE light shield.
- **Footswitch (9)** PN 36051
- **UV Bulb** – PN 38560 - 400 watt, metal halide. Optional visible (PN 36658) or mercury vapor (PN 36970) bulbs available.
- **Dymax ECE Series UV Flood-Lamp Systems User Guide** (Not Shown)

**Figure 3. ECE Series Flood-Lamp System Components**

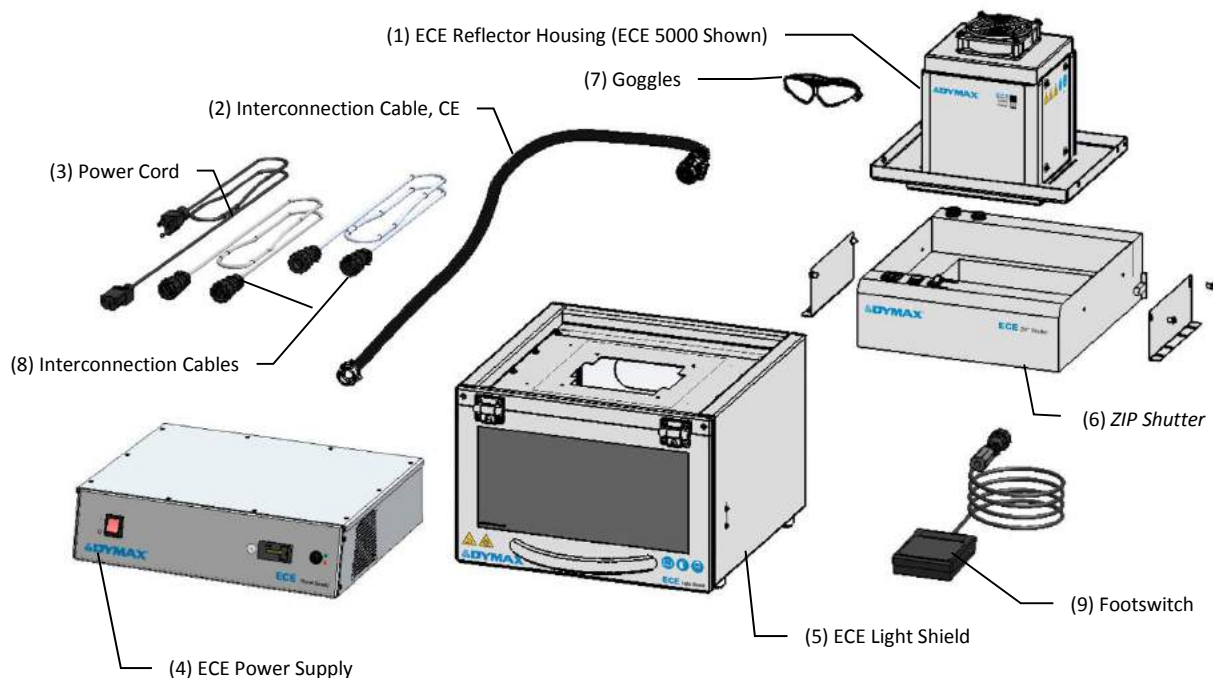

# System Interconnection



**WARNING!** Always observe safety requirements when working with electrical equipment!  
Electrical hazard is present!

Ensure that the power supply AC cord is unplugged before starting system interconnect.

**NOTE:** The only tool required for this procedure is a Philips-head screw driver.

Set-up and operation of your ECE system should be in a location that allows free air circulation around the sides and top of the Power Supply and Reflector Housing. 12 inches (30.5 cm) of space is recommended. Once an appropriate location has been determined, follow the instructions below to connect all system components.

1. Take the ECE ZIP™ Shutter and carefully place it on the top of the Light Shield.
2. Install the Securing Brackets to the top of Light Shield with the M4 x 8 mm screws provided.

**NOTE:** Do not tighten until directed to in Step 7.

3. Place the 400 watt Bulb into the Reflector Housing. Refer to the Bulb Replacement/ Installation section of this manual for complete instructions.
4. Install the Mounting Plates to the Reflector Housing. See specific instructions below.
  - **ECE 5000** - Place the Mounting Plate and the Air Plenum for the ECE 5000 onto the Reflector Housing. Attach all three components together with four new M4 x 25 mm screws. (Figure 5)

**Figure 4. ECE 5000 Reflector Housing with Mounting Plate**

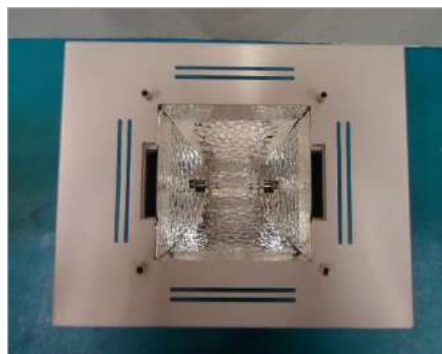

**Figure 5. ECE 5000 Reflector Housing with Mounting Plate and Air Plenum**



- **ECE 2000** – Place the Mounting Plate for the ECE 2000 onto the Reflector Housing. Attach the Mounting Plate with four M4 x 8 mm screws. (Figure 7)

**Figure 6. ECE 2000 Reflector Housing with Bracket**



**Figure 7. ECE 2000 Reflector Housing with Mounting Plate Installed**



5. Place the Reflector Housing/Mounting Plate Assembly into the Shutter.

**NOTE:** One side of the Mounting Plate has a third screw hole (Figure 8). When in the correct position, this screw hole will be at the rear of the Shutter.

**Figure 8. Reflector Housing/Mounting Plate Assembly, Third Screw Hole**



**ECE 5000**



**ECE 2000**

6. Using the M4 x 8 mm screws provided with the Shutter (Figure 9), secure the Light Shield and Shutter to the Reflector Housing Mounting Plate Assembly.

**Figure 9. Component Mounting Order**

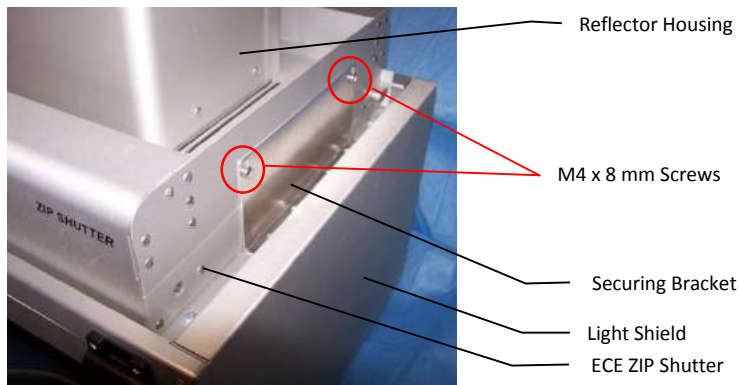

7. Center the Shutter on the Light Shield. When the desired position is achieved, tighten the Securing Brackets to the Light Shield.
8. Once the system components are properly mounted, connect the system cables and cords (Figure 10):
  - a. Interconnect Cable, PN 40695 – Connect one end of the cable to the J3 Receptacle on the Reflector Housing and the opposite end to the Lamp Power Receptacle on rear panel of the Power Supply.
  - b. Interconnect Cable, PN 40879 – Connect one end of the cable to the J4 Receptacle on the Reflector Housing and the opposite end to J1 Receptacle on the ECE ZIP Shutter.
  - c. Interconnect Cable, PN 40878 – Connect one end of the cable to the J5 Receptacle on the Reflector Housing and the opposite end to the receptacle on the rear of the ECE Light Shield.
  - d. If the foot switch is used, connect it to the Foot Switch Jack (J2) on the ECE ZIP Shutter.
  - e. Plug the Power Cord into the Power Module located in the rear panel of the Power Supply (Figure 11). Plug the opposite end into an external AC source. Turn on the Main Power Switch.

**Figure 10. Interconnection Diagram**

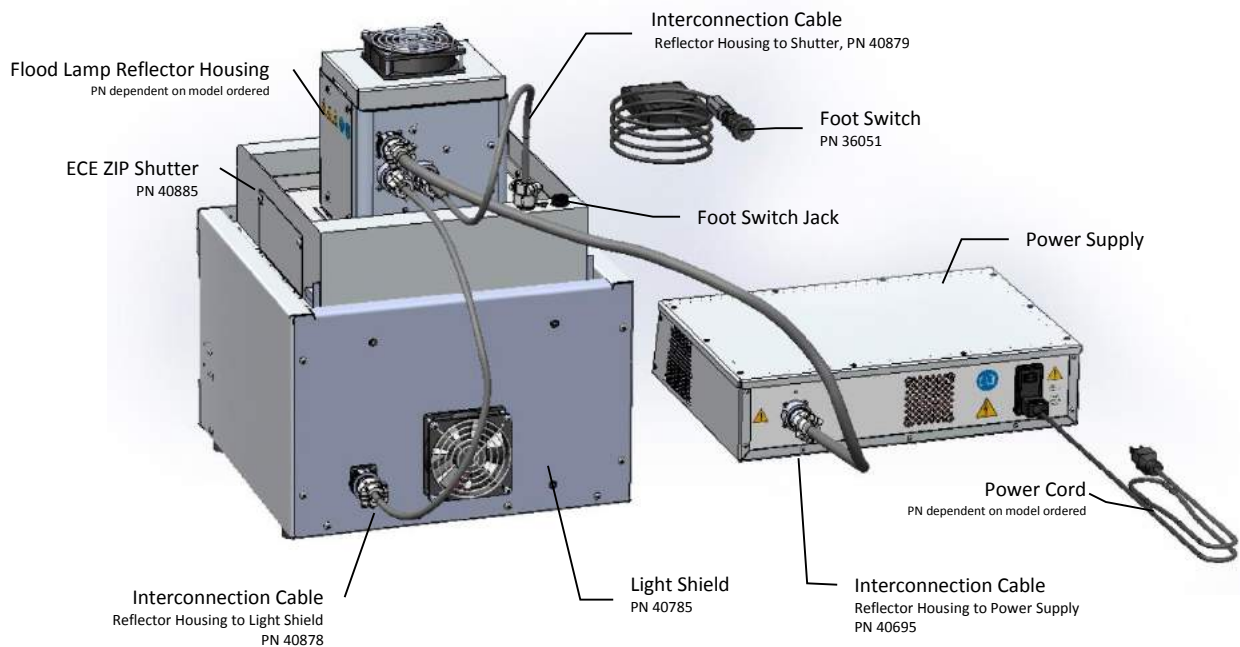

**Figure 11. Power Supply Rear Panel**

**WARNING!** Do not position the Light Shield on top of the Power Supply (Figure 12). The ECE Flood Lamp System requires adequate air circulation. Setting up the system in such a configuration can result in damage to the equipment and unsafe operating conditions.

**Figure 12. Unacceptable Mounting Configuration**

## Operation

### Starting the ECE Flood Lamp

Turn the unit on by pressing on the Power Switch (Figure 13) on the Power Supply. The Power Switch will light up to indicate that the power is on, the Fans will run, but the Flood Lamp will remain off. To light the Lamp, press the Lamp Igniter/Fault Indicator Button (Figure 13) on the right side of the front panel. The center of the button will illuminate green.

**NOTE:** While most lamps typically require less than 30 seconds to ignite, a new lamp may require extra time.

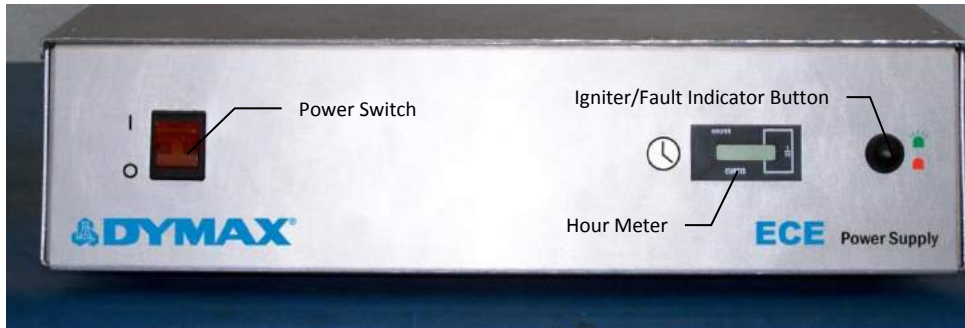

**Figure 13. Power Supply Front Panel**

After the lamp has ignited, allow five minutes for the lamp to reach its maximum output intensity.

These UV flood lamps are designed for continuous operation.

Lamp life is reduced approximately one hour each time it is started. To avoid premature lamp deterioration, leave the unit on through breaks, short shutdowns, and lunch hours.

**NOTE:** *If the power is momentarily lost or the lamp is inadvertently shut off, or is shut off due to an over-temperature condition, it must cool down before restarting. This may take 5-10 minutes depending on ambient conditions. The Power Supply may be left energized while the lamp is cooling. An operator will need to press the Igniter/Fault Indicator Button (Figure 13) to re-light the lamp when it has cooled sufficiently.*

Each time the lamp is turned on, it should operate for at least five minutes to allow complete ionization of elements inside the lamp. Failure to do this may result in failure of the lamp to restart. Refer to the troubleshooting section of this manual for more information.

## Loading Materials in the Light Shield

1. Once the ECE lamp is ready, check that the ECE *ZIP Shutter* is in the closed position, and load parts to be cured on the Light Shield work surface (preferably in line with the center of the shutter).

**NOTE:** *The ECE ZIP Shutter will close automatically and the lamp will shut off when the access door is opened.*

2. Estimate the height of the curing part in respect to its base, or to the base of the part holder (if the object to be cured is not free standing), and then adjust the position of the work surface at a proper distance from the curing part. Use a ruler for setting accuracy.
3. The tray can be adjusted from 1.5 in to 5.5 in [3.81 cm to 13.97 cm] down from the cover of the enclosure. You can set this distance differently to optimize your throughput with respect to adhesive properties and irradiant energy required to achieve the best curing quality in the shortest time. Dymax Application Engineering is ready to assist you if needed.
4. Adjust the distance from the bottom plane of the ECE *ZIP Shutter* to the surface to be cured.
5. Close the Light Shield Door once the parts to be cured are loaded.

## Operating the Shutter

1. With the Light Shield Door closed, set the exposure (ECE ZIP Shutter "Open Time") by adjusting +/- the Push-Button Counter located next to the Actuate Button on the Front Panel.
2. Open the ECE ZIP Shutter using the most convenient method for you by using Push Actuator Button or Foot Switch.

**NOTE:** The ECE ZIP Shutter will close automatically in timed mode or will stay open until you release the Foot Switch or Actuator Button in manual mode.

3. Close the ECE ZIP Shutter to end the cycle.

## Operational Safety Interlock for ECE Flood System

The safety interlock for the ECE Flood System operates to reduce the operational hazard of the unit. In the event that the lamp is on and the shutter and light shield are also open, power to the lamp will turn off and the Lamp Igniter Switch on the front of the Power Supply will change from GREEN (lamp is on and operational) to RED (lamp is off and non-operational).

There are three methods of operation for the given safety circuit condition below:

Shutter Condition	Light Shield Condition	Lamp Condition	Safety Circuit Output Result	Color of Lamp Igniter Switch
Shutter Closed	Light Box Closed	Lamp On	Lamp Stays On	Green
Shutter Open	Light Box Open	Lamp On	Lamp Turns Off	Red
Shutter Closed	Light Box Open	Lamp On	Lamp Stays On	Green

# Cleaning and Maintenance

## ECE Flood Lamp Maintenance

### Power Supply Maintenance

Dymax recommends cleaning the intake and exhaust vents of the power supply twice a year at a minimum. This can be done with a vacuum.

### Bulb Replacement Procedure

Every new 400 watt ECE series UV light-curing flood lamp is supplied with a new bulb. When the bulb requires replacement, the following procedure must be followed:

- Step 1. Turn the Power Switch off and disconnect the Power Supply from the electrical power source. Allow the entire assembly to cool for 15 minutes.



**CAUTION!** The bulb operates at temperatures exceeding 500°C. Touching the Bulb before sufficient cool down time is allowed will cause severe burns. Always wear safety eye wear while replacing the bulb.

Always use a soft, clean rag, paper towel, or gloves when handling the bulb. Skin oils left on the bulb will burn into the quartz, reducing output intensity. If the bulb is inadvertently touched, clean the Bulb thoroughly with a soft, clean rag and IPA.

Step 2. Hold the Lamp/Reflector Assembly Housing securely and remove the Mounting Hardware from the Lamp/Reflector Assembly Housing Bracket. Lift the housing off the ZIP Shutter and place it upside down on a clean work surface.

Step 3. Reach into the Reflector and grasp the flat area of Bulb at either end (Figure 14). Lightly push the Bulb toward the Socket on the opposite end of the lamp so that the end being grasped can be lifted clear of the Socket (Figure 15). Install the new Bulb by following Steps 4 & 5 in the reverse order.

**IMPORTANT:** Install the Bulb so the seal dimple on the bulge of the glass is facing towards the Reflector surface. Avoid touching the Quartz Tube with your fingers.

**NOTE:** Bulb has no polarity.

**Figure 14. Flood Lamp Bulb Installed**

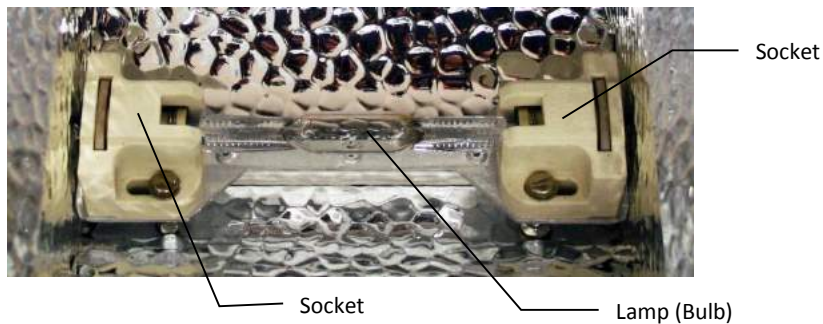

**Figure 15. Push Bulb Towards Socket**

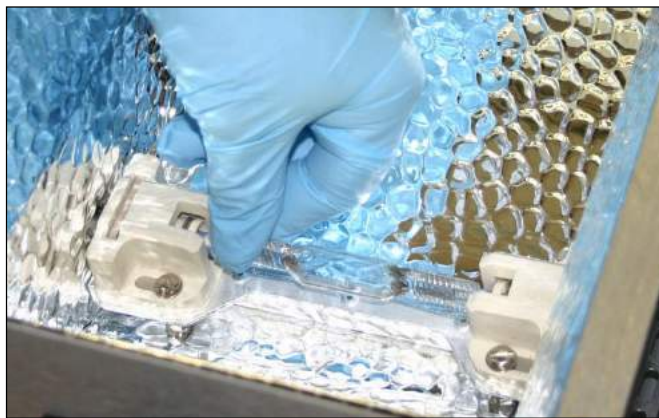

**Figure 16. Lift Bulb**

- Step 4. Record the serial number of the unit and the hour-meter reading in the Bulb History Record.
- Step 5. Replace the Lamp/Reflector Assembly Housing on the ECE ZIP Shutter by engaging the Mounting Bracket.
- Step 6. Secure the Thumbscrew when the Lamp/Reflector Assembly Housing is at the proper height.
- Step 7. Reconnect the Power Cord to the appropriate power source.
- Step 8. Turn the Power Switch on and allow the lamp to warm up for five minutes before using.

**NOTE:** *If the lamp does not ignite, refer to the troubleshooting section of this manual.*

### Lamp Base Replacement Kit

Installation Instructions:

1. Turn off the power.
2. Remove the Power Cord and Interconnect Cord from the unit.
3. Remove the Lamp/Reflector Assembly and place it on a clean, flat surface with the Lamp facing up.
4. Remove the Lamp (refer to Lamp Replacement Procedure).
5. Remove the Lamp/Reflector Assembly from the housing by removing the four screws, two on each side, from the Reflector.
6. Remove the two screws that hold the Igniter (located inside a blue fireproof sleeve) in place from the side of the unit. Remove the Igniter from the sleeve.
7. Loosen the screws and remove the wires from the Igniter at locations marked "N" and "La".
8. The black Teflon® wire at location "N" will have to be clipped from the Lamp Base Wire and re-stripped.
9. Remove both Lamp Bases and install the new Lamp Bases from the Lamp Base Replacement Kit.
10. Take one of the Lamp Bases and crimp on a supplied Terminal (PN 35202). This wire will be installed in the "La" location on the Igniter.

11. The remaining Lamp Base Wire will be joined with the black Teflon® wire using the supplied Terminal (PN 35218). This wire will be installed in the "N" location on the Igniter.
12. Place the Igniter back into the blue Fireproof Sleeve and fasten it to the side of the Housing using the two screws that had been removed in Step 6.
13. Place the Reflector back into the Housing and fasten with the four remaining screws.
14. Place the Lamp back into the unit.

## Fuse Replacement Procedure

The ECE series 400 Watt Power Supply utilizes two Line-Input Fuses. These fuses are external and are located in the Power Cord Receptacle at the rear of the Power Supply Housing. The fuses are 6.3 amp, slow-blow fuses.



**WARNING!** *Electrical shock hazard. Exercise extreme care when replacing fuses. Make sure only qualified personnel perform fuse replacement and that all power switches are off and the power cord is unplugged.*

### Replacing External Fuses

1. Turn the Power Switch on the Power Supply off.
2. Unplug the Power Cord from the electrical source.
3. Unplug the Power Cord from the Power Cord Receptacle at the rear of the Power Supply Housing.
4. Place a small, flat-blade screwdriver into the notch at the top of the Plug Recess and pull the Fuse Cover downwards approximately 70 degrees. The Fuse Retainer should be exposed and should be removed by pulling it straight out (Figure 17).
5. Slide out the blown Fuses and replace with new 6.3 Amp, slow-blow Fuses.

**CAUTION!** *It is important to replace this Fuse with the same 6.3 Amp rated, slow-blow type.*

6. Slide the Fuse Holder back into the Receptacle until it is fully seated, then rotate the cover upward until it latches.
7. Install the Power Cord and connect it to the electrical power source.
8. Turn the Power Switch on.

**Figure 17. Replacing Fuses**



## Cleaning the Flood Lamp

Periodically clean the Bulb and Reflector surfaces. A soft, clean, lint-free cloth and any standard glass cleaner should be used. Heavier deposits may require cleaning with isopropyl alcohol.

**CAUTION!** *Cleaning the Reflector with a rough or dirty cloth will result in a dulled surface, thereby, reducing reflectance and decreasing UV output. Use only a soft, clean, lint-free cloth.*

Any uncured resins spilled onto the Flood Lamp can be removed with isopropyl alcohol and a clean cloth.

## ECE Light Shield Maintenance

The UV light shield is designed to be maintenance free. Periodic cleaning will ensure long trouble-free operation.

## ECE ZIP Shutter Maintenance

### Check and Adjust Curtain Drive-Belt Tension

Dymax recommends that the ECE ZIP Shutter's Curtain Drive-Belt's tension be checked at least once every three months. Follow the instructions below to check the Curtain Drive-Belt's tension.

**Figure 18. Belt Tension Adjustment**

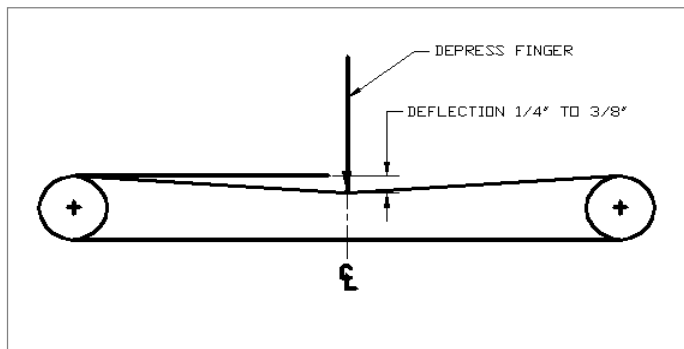

1. Turn off and disconnect the Lamp Reflector Housing from the external AC source.
2. Remove the ECE ZIP Shutter from the Flood Lamp Reflector Housing and place it on the bench, bottom-side up.
3. Remove the screws that attach the ZIP Shutter's bottom panel.
4. Very lightly press in the center of the Curtain Drive Belt with a finger; the Belt should deflect no more than  $\frac{1}{4}$ " to  $\frac{3}{8}$ ".
5. If deflection exceeds this value, tighten the Curtain Drive Belt by adjusting the Tension Screw in the back of the ECE ZIP Shutter.

**NOTE:** *Make sure that both belts are tightened equally.*

6. Replace the bottom cover and secure it with its screws.
7. Place the ECE ZIP Shutter back on the Flood Lamp Reflector Housing and re-position it.
8. Reconnect the cables and plug the AC cord into wall socket.

## ECE ZIP Shutter Curtain Assembly Replacement

Dymax recommends that you check the *ECE ZIP Shutter* curtain for wear each time you change the lamp. If it shows any signs of wear, replace it. Additional curtain assembly replacements can be purchased through Dymax Customer Service.



**CAUTION! SHARP EDGES!** *The edge of the stainless steel curtain is extremely sharp. To prevent injuries, always wear gloves that are resistant to cuts when handling or installing equipment. We recommend, at a minimum, CE Cut Level 5 gloves (included with kit).*

**Figure 19. ECE ZIP™ Curtain Assembly Diagram ( Bottom View )**

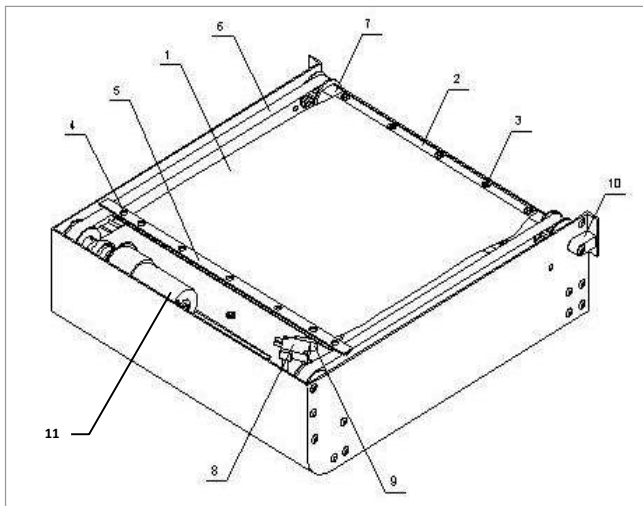

#	Description
1	Curtain
2	Roller Bar
3	Screws (5)
4	End Screws (2)
5	Clamp Bar
6	Belts
7	Roller and Pulley
8	Limit Switch
9	Limit Switch Standoff
10	Belt Tension
11	Belt Drive Motor

1. The Stainless Steel Curtain Assembly Kit (PN 41097) will contain the items show in Figure 20. If you are replacing a stainless steel curtain, items 3, 5, and 6 are not needed.

**Figure 20. Stainless Steel Curtain Assembly Kit**

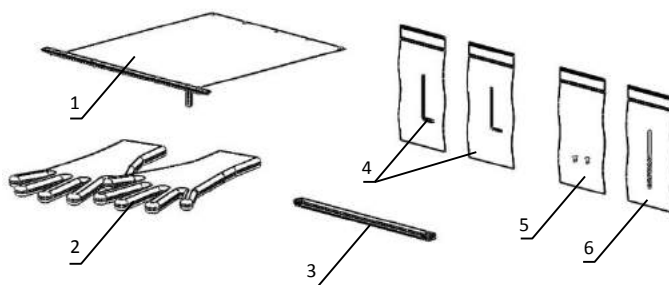

#	Description
1	SS Curtain Assembly
2	Cut-Resistant Gloves (Level 5)
3*	Black Protective Wear Strip
4	Allen Wrenches
5*	M3 x 6 mm Screws (Qty: 2)
6*	Drill Bit #30

\*Not needed if reoplacine a stainless steel curtain

2. After putting on the recommended cut-resistant gloves, remove the three Retaining Screws on each side of the Lower Cover of the Shutter (Figure 22). Use the 2-mm Allen Wrench provided to do so.

**Figure 21. ZIP™ Shutter – Top View**

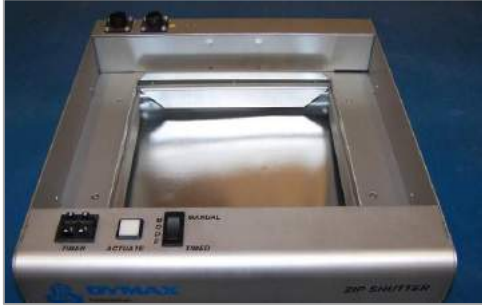

**Figure 22. Retaining Screws**



3. Remove the three Phillips-Head Retaining Screws on the bottom of the Lower Cover of the Shutter (Figure 23). Lift the cover off the Shutter to reveal the inner Curtain Assembly (Figure 24).

**Figure 23. Phillips-Head Retaining Screws**



**Figure 24. Inner Curtain Assembly (Kevlar Curtain Shown)**



4. Manually unroll the Curtain until the Curtain reaches the Front Limit Switch. Loosen the two End Screws (Figure 25) on the pulley side to release the grip from the Drive Belt.
5. Remove the five Retaining Screws holding the Curtain to the Roller Bar. This will remove the Curtain Assembly from the Shutter.
6. To install the new Stainless Steel Curtain (PN 41097), affix the new Curtain to the Roller Bar first, using the five Retaining Screws. (Figure 26)

**CAUTION!** Use gloves rated at a minimum a CE cut level 5 when installing the stainless steel material. The edges are very sharp and can cut during installation.

**Figure 25. Loosen End Screws**



**Figure 26. Five Retaining Screws**





- Stretch the Curtain toward the front of the Shutter. When the Curtain is fully stretched out, loosen the two End Screws and slide the Clamp Bar onto the Belt (Figure 28). The Curtain should be stretched short of the Front Limit Switch.

**Figure 27. Install Curtain to Roller Bar with five Retaining Screws**

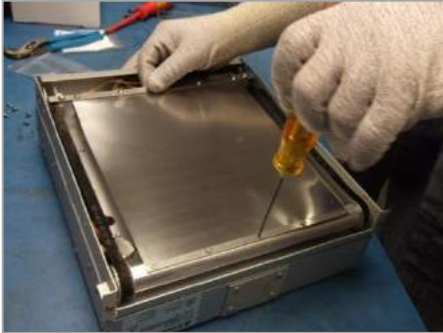

**Figure 28. Slide the Clamp Bar onto the Belt**



- Tighten the both M4 x 6 mm End Screws (Figure 29).
- Manually roll-up the Curtain until it reaches the Rear Limit Switch (Figure 30). If the Clamp Bar bows, loosen the screws and allow the Clamp Bar to find its natural straightness and retighten.

**Figure 29. Tighten the M4 x 6 mm End Screws**



**Figure 30. Rear Limit Switch**

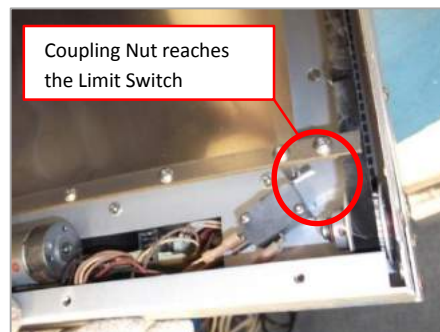

- If changing a Kevlar Curtain to a Stainless Steel Curtain, the following steps are needed to install the wear strips. If you are changing out a Stainless Steel Curtain, proceed to step 17. The Wear Strips should already be installed.
- Locate the roller-end of the Bottom Housing Plate. It contains the square notch and two location holes (Figure 31).
- Place the Protective Wear Strip onto the Bottom Housing Plate (Figure 32). Use a marker to mark the location of the two holes.

*Note: Slots located on Black Protective Wear Strip.*

**Figure 31. Roller End of the Bottom Housing Plate**

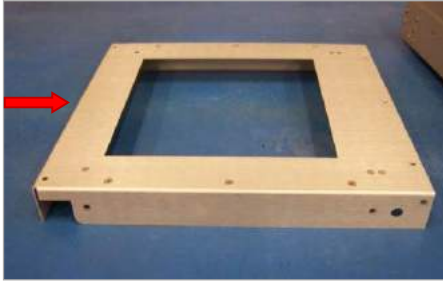

**Figure 32. Protective Wear Strip**



13. Slide the Wear Strip up and out of the way. Insert Drill Bit #30 into a Drill Head. Be sure to tighten the Drill Head to ensure that the drill does not slip during operation.

*NOTE: Always wear the appropriate personal protective equipment when using power tools.*

14. Use a Hammer and a Pointed Punch to create a punch mark at the marked locations and then drill holes thru the two marked locations (Figure 33).
15. Place the Wear Strip back down and confirm the holes line up with the holes just drilled.
16. Install the two M3 x 6 mm Screws (Figure 34).

**Figure 33. Drill Holes**

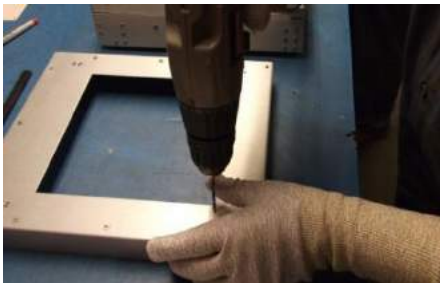

**Figure 34. Install M3 x 6 mm Screws into Wear Strip**



17. Reinstall the Bottom Housing on the ZIP™ Shutter.
18. Set-up the system according to the Shutter directions. Tighten the belt tension as needed to improve the belt performance.



# Troubleshooting

If your ECE flood lamp is not responding as expected, please refer to the troubleshooting table below.

**NOTE:** When contacting Dymax, an authorized Dymax distributor, or manufacturer's representative, be sure to know and provide the following:

- Model number of equipment in question.
- Serial number of equipment in question.
- Product number of the adhesive in question (if applicable).
- Lot number of the adhesive in question (if applicable).

All returns to Dymax must be accompanied by a Return Merchandise Authorization (RMA). This number must be obtained from a Dymax Customer Service Representative.

**Table 1. Troubleshooting Chart for ECE ZIP Shutter**

Problem	Possible Cause	Testing	Corrective Action
The shutter curtain does not open or close smoothly	One of the tension screws is not tight enough	All functions of the <i>ZIP Shutter</i> operate properly	Adjust the curtain tension.
The shutter's motor continuously runs	One of the Limit Switches is not engaging properly	All functions of the <i>ZIP Shutter</i> operate properly	Adjust the micro-switch activating blade.
The shutter will not operate	No power at shutter	Verify the supply voltage being delivered to the shutter. Test the voltage at pins 1 & 2 of the 8-pin connector (24 VDC)	Check and replace wiring If light source is operational and <i>ZIP Shutter</i> is not. If a problem occurs within the light source, consult manual.
	The plug (38317 or 38318) is not installed in J5 of the reflector housing	All functions of the <i>ZIP Shutter</i> operate properly	Install the plug as described in the installation instructions.

**Table 2. Troubleshooting Chart for ECE Flood Lamps**

<b>Problem</b>	<b>Possible Cause</b>	<b>Testing</b>	<b>Corrective Action</b>
Lamp Will Not Ignite  or  Lamp Flickers, Won't Maintain Operation	Improperly fastened connections	Visually inspect all connections to and from the Power Supply.	Secure all connections.
	Main Line Fuses blown	Remove Fuses from Power Receptacle and check with an Ohmmeter.	Replace Fuses, if defective.
	Corroded Lamp Bases	Visually inspect the Lamp Bases for any signs of corrosion.	Replace the Lamp Bases if corrosion exists (both Lamp Bases should be replaced at the same time).
	Bulb beyond its useful life	Replace the Bulb with a Bulb that is good and re-test unit.	Replace the Bulb if defective (typical Bulb life = 2,000 hours).
	Power Supply Board failed	If a second ECE Flood Power Supply is available, connect it to the Reflector Housing and check for Bulb ignition.	If the lamp lights with the second Power Supply, call Dymax for a Return Merchandise Authorization (RMA). The Power Supply has failed.
	Igniter malfunctioned	If a second ECE Reflector Housing is available, connect it to the Power Supply and check for Bulb ignition.	If the lamp lights with the second Reflector Housing, call Dymax for a RMA. The Reflector Housing has failed.
Unit Blows Input Fuse	Malfunction in the Power Supply Board	Remove power. Disconnect the Lamp/Reflector Assembly from the Power Supply. Replace the Fuse. Apply power. If a Fuse blows, the Power Supply is defective.	Call the Dymax for a RMA. The Power Supply has failed.
The UV Intensity Appears To Be Low	The bulb is beyond its useful life	Use a Radiometer (ACCU-CAL™ 50) to measure actual output intensity. Consult manual for proper output.	Replace the Bulb if beyond the useful life.
	The Quartz Envelope on the bulb is contaminated	Visually inspect the Bulb for signs of contamination (Quartz Envelope must be free from any contamination).	Clean the Bulb with a soft, lint-free cloth and isopropyl alcohol. The Bulb may have to be replaced if contamination is burned into Quartz Envelope.
	Surfaces of the Reflector may be contaminated	Examine Reflector surface for contaminants (should be a clean, shiny surface).	Clean the Reflector with a soft, lint-free cloth and isopropyl alcohol or an equivalent.

# Spare Parts and Accessories

## Replacement/Spare Parts

Item	Part Number
<b>Fuses</b>	
Fuse, F 6.3 Amp	41098
<b>Personal Protection Equipment</b>	
Protective Goggles – Gray (standard model included with unit)	35285
<b>Lamps</b>	
Lamp, Metal Halide 400 Watt UV (Standard)	38560
Lamp, Mercury Vapor 400 Watt UV (Optional)	36970
Lamp, Visible 400 Watt (Optional)	36658
Lamp Base Replacement Kits	35979
<b>Miscellaneous</b>	
Light Shield	40785
ECE ZIP Shutter	40885
Power Switch	39953
Light Shield Tray	40796

## Optional Accessories

Optional accessories are available to enhance efficiency and operation of Dymax ECE series UV light-curing flood lamps. Contact your authorized Dymax distributor, manufacturing representative, or Dymax for more information on these options.



### UV Radiometer (PN 40550)

Dymax offers an ACCU-CAL™ 150 for monitoring the UV intensity of the ECE-Series Flood Lamps. This Radiometer is calibrated to measure UVA output (320-390 nm) wavelength.

Features include:

- Measures light intensity in mW/cm<sup>2</sup>
- Powered by AAA batteries (included)
- Stores in molded plastic case (included)

# Specifications

## Specifications



Property	Specification	
Models	ECE 2000 System	ECE 5000 System
<b>Part #</b>		
No Power Cord*	<b>40830</b>	<b>40840</b>
North American Version, Power Cord with 120V Plug	<b>41040</b>	<b>41030</b>
Asian Version, Type G Power Cord	<b>41060</b>	<b>41050</b>
<b>Unit Warranty</b>	1 year from purchase; see warranty section for more information.	
<b>Flood Lamp Specs</b>		
<b>Typical Initial Output Intensity UVA** (320 - 390 nm)</b>	105 mW/cm <sup>2</sup>	225 mW/cm <sup>2</sup>
<b>Weight</b>	3.4 lbs. [1.5 kg]	2.7 lbs. [1.2 kg]
<b>Dimensions, W x D x H</b>	10.5" x 9.0" x 7.5" [26.7 x 22.9 x 19.1 cm]	6.75" x 6.75" x 8.0" [17.2 x 17.2 x 20.3 cm]
<b>Power Supply Dimensions (approx.), W x D x H</b>	15.75" x 11.6" x 3.8" [39.9 cm x 29.5 cm x 9.65 cm]	
<b>Hour Meter</b>	99,999.9 hours (non-resettable)	
<b>Electrical Power Output</b>	400 Watts	
<b>Operating Temperature</b>	0 to 40°C	
<b>Storage Temperature</b>	-20 to 80°C	
<b>Operating Humidity</b>	0-90 % (non-condensing)	
<b>Line Voltage</b>	100 - 240 VAC +/-10% Single Phase	
<b>Line Frequency</b>	47-63 Hz	
<b>Current Consumption (max)</b>	@115 VAC      6.30 A @230 VAC      3.15 A	
<b>Inrush Current (max)</b>	12.6 A / 2.2 ms	
<b>Electrical Regulation</b>	+/- 2.5% for effects of load, line, temperature	
<b>Power Supply Output to Lamp</b>	VAC, 3.1A	
<b>Output Protection</b>	Short circuit and overload protected	
<b>Auxiliary DC Outputs</b>	+24V, 1.5A available for lamp housing fan and shutters	
<b>Bulbs</b>	<b>38560</b> 400 watt, metal halide (standard) <b>36970</b> 400 watt, mercury vapor (optional) <b>36658</b> 400 watt, visible (optional)	
<b>Bulb Life</b>	2,000 hours (bulb ignition only)	
<b>Certifications</b>	RoHS compliant, CE marked	

\* The appropriate power cord will be added for European customers.

\*\* Intensity readings vary widely depending on the make and model of the radiometer. These intensities were measured with the ACCU-CAL™ 50 radiometer.

Property	Specification
<b>Light Shield Specs</b>	
Work Area	10" x 10" (25.4 cm x 25.4 cm)
Work Surface Load Capacity	Up to 5 lbs.
Overall Dimensions (W x D x H)	15.1" x 18.2" x 10.6" [38.42 cm x 46.25 cm x 26.83 cm]
Weight (Light Shield Only)	12.75 lbs [5.78 kg]
<b>ECE ZIP Shutter Specs</b>	
Operating Voltage	24 VDC (Supplied by the Dymax ECE Power Supply)
Exposure Time	Digital Setting - From 1 to 99 Seconds
Aperture	6" x 8" [15.24 cm x 20.32 cm]
Operation Modes	Timed/Manual
Dimensions, W x D x H	12.5" x 12.9" x 3.8" [31.8 cm x 32.8 cm x 9.7 cm]

Figure 35. ECE Flood Lamp Spectral Output

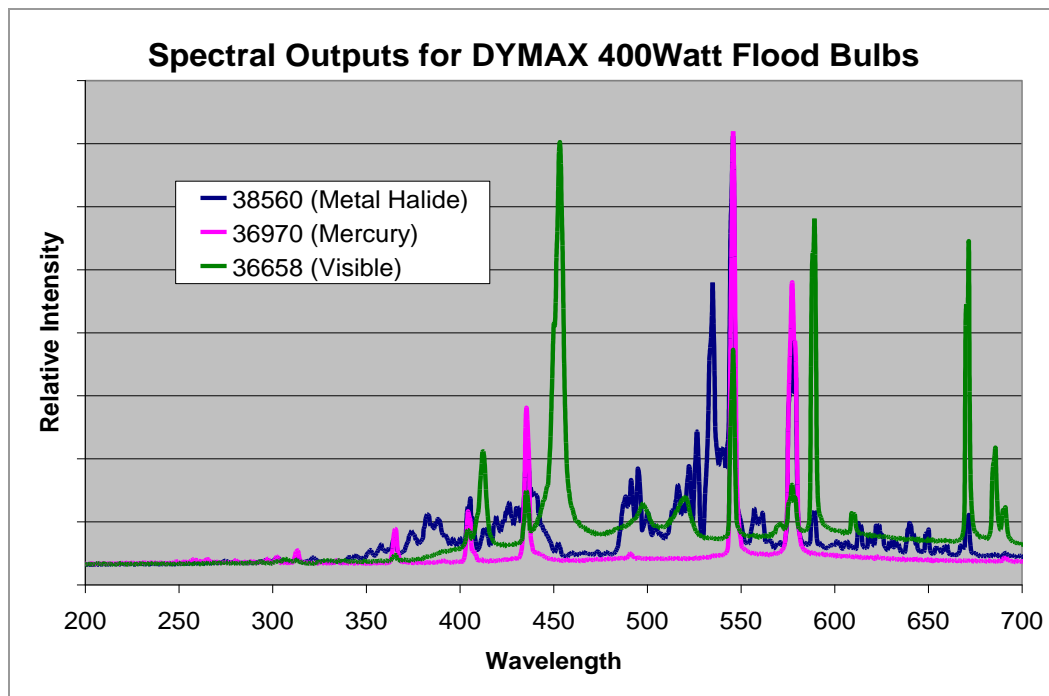

# Definition of Terms

**Dose** - irradiance integrated over time, or Irradiance (W/cm<sup>2</sup>) x Time (s) = Dose (Joules/cm<sup>2</sup>).

**NOTE:** *Watt is the power that gives rise to the production of energy at the rate of 1-joule (J) per second (s).*

**Flood-Lamp System** - set of components arranged to generate, collect, condition and direct UV radiant energy to perform curing of engineering adhesives, coatings, and inks within a safe and controlled process. It includes a lamp housing and power supply and may also include a shutter, workstation, UV enclosure, Dymax light shield, and/or accessories.

**Intensity** - a measure of light energy over the unit of surface area (usually the surface at the specified working distance from the bottom of the reflector housing) in W/cm<sup>2</sup> or mW/cm<sup>2</sup>.

**Lamp** - light source (bulb or burner) generating ultraviolet, visible, and infrared radiant energy from burning matter stimulated by electrical power conditioned by a proper power supply which is an integral part of a lamp. A light source is usually placed into a reflector (of various geometry) to increase light source efficiency by collecting and directing radiant energy of selected spectra (for a given curing process).

**Ozone** - oxidizing agent (O<sub>3</sub>) produced by the action of ultraviolet radiant energy (below 185 nm) or electrical corona discharge of oxygen on air.

**Ultraviolet (UV)** - The invisible region of the spectrum just beyond the violet end of the visible region. Wavelength ranges in general from 1.0 to 400 nm. Dymax lamps (bulbs) do not radiate energy in deep ultraviolet; there are very minute amounts below 220 nm and practically nothing can be sensed below 200 nm. This is due to the use of ozone-blocking quartz bulb envelope (See Ozone).

Ultraviolet is used beneficially in various fields of industry and medicine. In order to standardize light sources used in medicine, the International Congress on Light, in Copenhagen in 1932, recommended dividing the ultraviolet spectrum into three spectral parts:

- **Ultraviolet A (UV-A)** - UV of long wavelength from within approximately 400 to 320 nm of the spectral band (4000 to 3200 $\oplus$ ) - predominately produced by Dymax flood lamps.
- **Ultraviolet B (UV-B)** - UV of medium wavelength from within approximately 320 to 280 nm - Dymax flood lamps produce some amount of their energy within this bandwidth.
- **Ultraviolet C (UV-C)** - UV of short wavelength below 280 nm (we say from 280 to 200 nm) - a large amount of this energy is present in the sunlight.

## Cautionary Statements Are Defined As:

- **Warning** - is used when there is a hazardous situation that has some probability of severe injury.
- **Caution** - is used to indicate a hazardous situation that may result in minor or moderate injury.
- **Notice** - is used to convey a message related directly or indirectly to the safety of personnel, or protection of property.

# Warranty

From date of purchase, Dymax Corporation offers a one-year warranty against defects in material and workmanship on all system components (excluding lamp/bulb) with proof of purchase and purchase date. Unauthorized repair, modification, or improper use of equipment may void your warranty benefits. The use of aftermarket replacement parts not supplied or approved by Dymax Corporation will void any effective warranties and may result in damage to the equipment.

**IMPORTANT NOTE:** DYMAX CORPORATION RESERVES THE RIGHT TO INVALIDATE ANY WARRANTIES, EXPRESSED OR IMPLIED, DUE TO ANY REPAIRS PERFORMED OR ATTEMPTED ON DYMAX EQUIPMENT WITHOUT WRITTEN AUTHORIZATION FROM DYMAX. THOSE CORRECTIVE ACTIONS LISTED ABOVE ARE LIMITED TO THIS AUTHORIZATION.

# Index

- Adjust Curtain Drive Belt Tension, 20
- Assembly and Setup, 9
- Bulb Replacement, 16, 19
- Cleaning, 19
- Curing System Safety, 5
- Damaged Parts, 9
- Definition of Terms, 30
- Fuse Replacement, 18
- Glossary, 30
- Help, 4
- Lamp Base Replacement, 17
- Missing Parts, 9
- Optional Accessories, 27
- Optional Equipment, 27
- Product Overview, 7
- Replace Bulb, 16, 19
- Replace Fuses, 18
- Replace Lamp Base, 17
- Safety of UV Light
  - Bright Visible Light, 7
  - High-Temperature Surfaces, 7
  - Ozone, 7
  - UV Exposure, 5
- Spare Parts and Accessories, 27
- Specifications, 28
- Spectral Output Chart, 29
- Support, 4
- System Components, 8
- Troubleshooting, 25, 26
- Unpacking, 9
- UV Exposure, 5
- UV Light Shielding, 6
- Warranty, 31
- Zip Shutter Curtain Replacement, 21, 22, 24



© 2012-2016 Dymax Corporation. All rights reserved. All trademarks in this guide, except where noted, are the property of, or used under license by Dymax Corporation, U.S.A. Teflon is a registered trademark of DuPont.

**Please note that most dispensing and curing system applications are unique.** Dymax does not warrant the fitness of the product for the intended application. Any warranty applicable to the product, its application and use is strictly limited to that contained in Dymax's standard Conditions of Sale. Dymax recommends that any intended application be evaluated and tested by the user to ensure that desired performance criteria are satisfied. Dymax is willing to assist users in their performance testing and evaluation by offering equipment trial rental and leasing programs to assist in such testing and evaluations. Data sheets are available for valve controllers or pressure pots upon request.

PN 40948      MAN048      7/13/2016

---

**Dymax Corporation**  
+1.860.482.1010 | info@dymax.com | [www.dymax.com](http://www.dymax.com)

**Dymax Europe GmbH**  
+49 (0) 611.962.7900 | info\_de@dymax.com | [www.dymax.de](http://www.dymax.de)

**Dymax Engineering Adhesives Ireland Ltd.**  
+353 21.237.3016 | info\_ie@dymax.com | [www.dymax.ie](http://www.dymax.ie)

**Dymax Oligomers & Coatings**  
+1.860.626.7006 | info\_oc@dymax.com | [www.dymax-oc.com](http://www.dymax-oc.com)

**Dymax UV Adhesives & Equipment (Shanghai) Co. Ltd.**  
+86.21.37285759 | dymaxasia@dymax.com | [www.dymax.com.cn](http://www.dymax.com.cn)

**Dymax UV Adhesives & Equipment (Shenzhen) Co. Ltd.**  
+86.755.83485759 | dymaxasia@dymax.com | [www.dymax.com.cn](http://www.dymax.com.cn)

**Dymax Asia (H.K.) Limited**  
+852.2460.7038 | dymaxasia@dymax.com | [www.dymax.com.cn](http://www.dymax.com.cn)

**Dymax Asia Pacific Pte. Ltd.**  
+65.6752.2887 | info\_ap@dymax.com | [www.dymax-ap.com](http://www.dymax-ap.com)

**Dymax Korea LLC**  
+82.2.784.3434 | info\_kr@dymax.com | [www.dymax.com/kr](http://www.dymax.com/kr)